

TP-40R19(左物置)

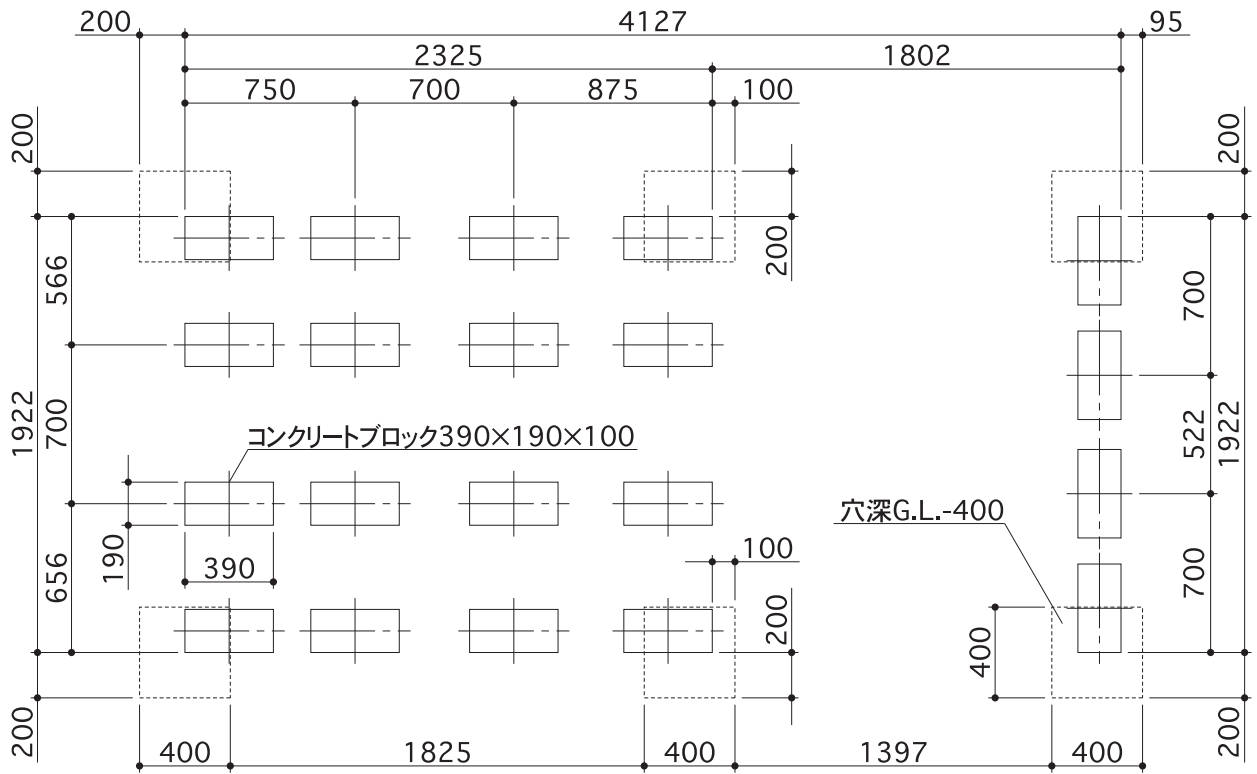

出入口側

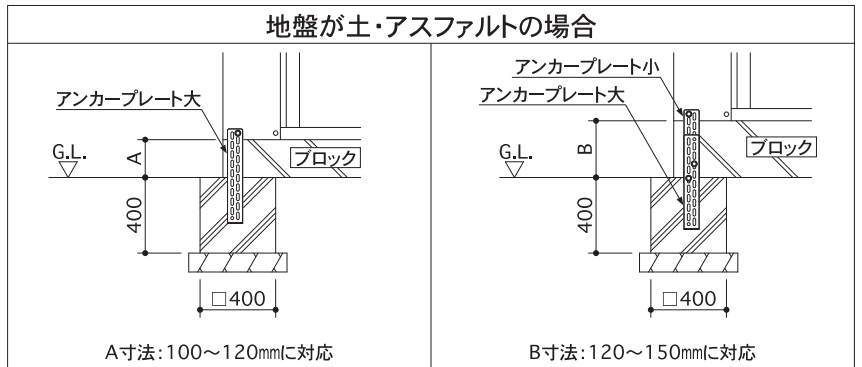
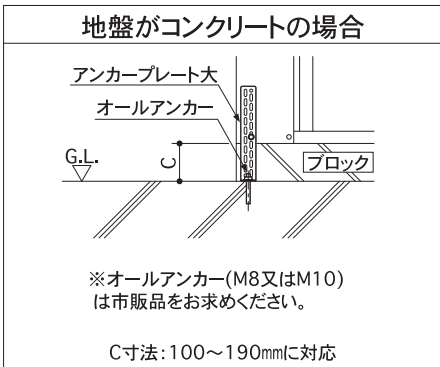

TP-40R19(右物置)

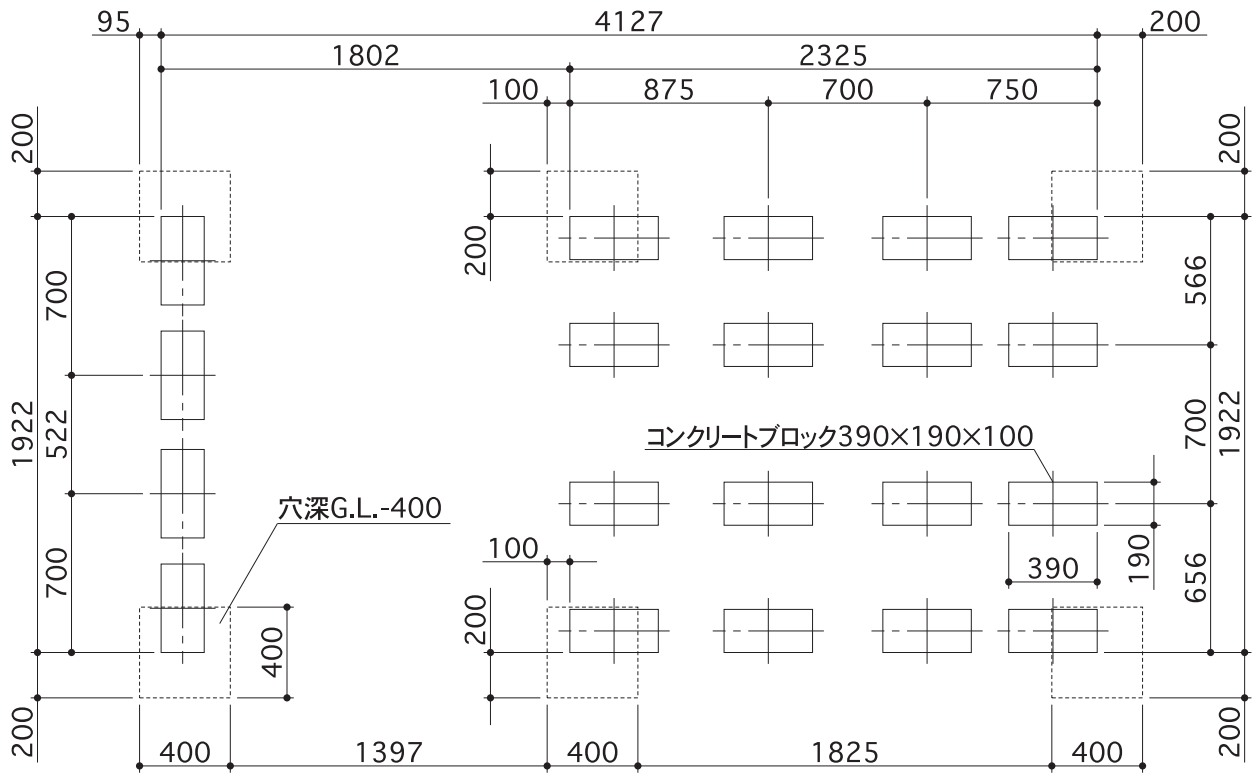

出入口側

