

TP-4019(左物置)

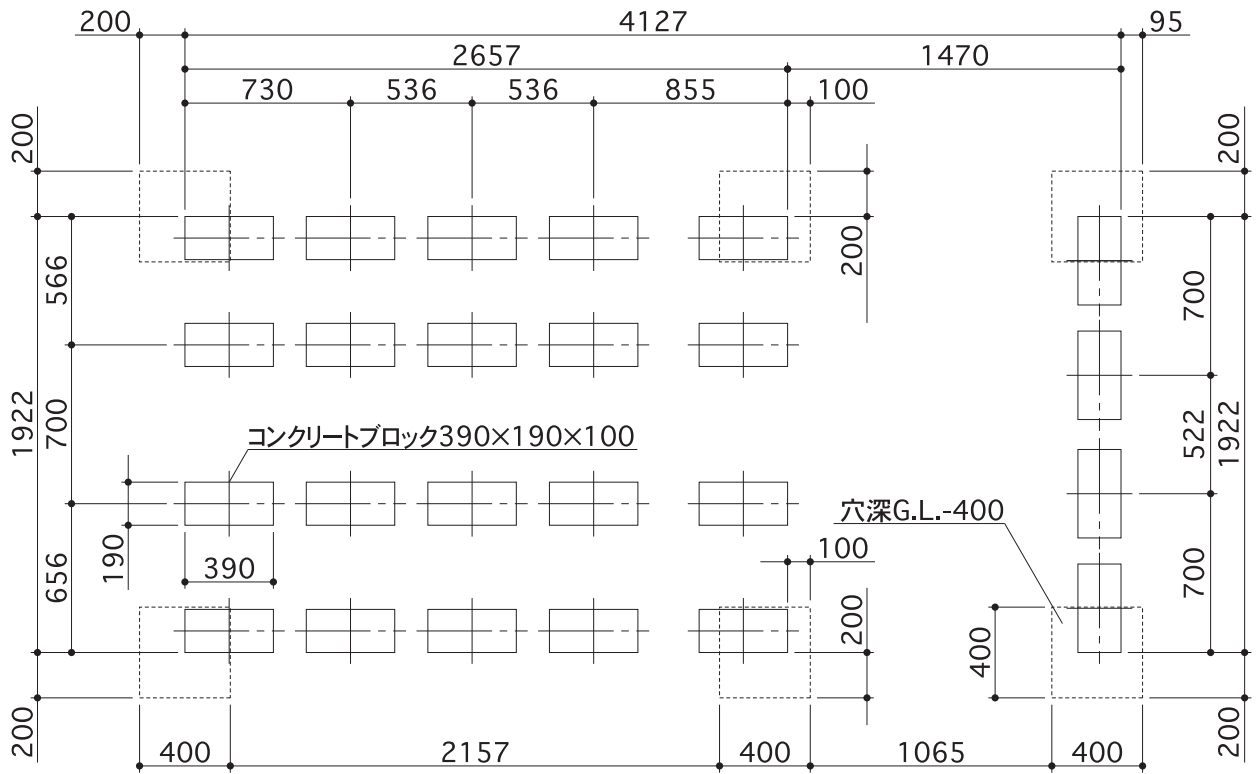

出入口側

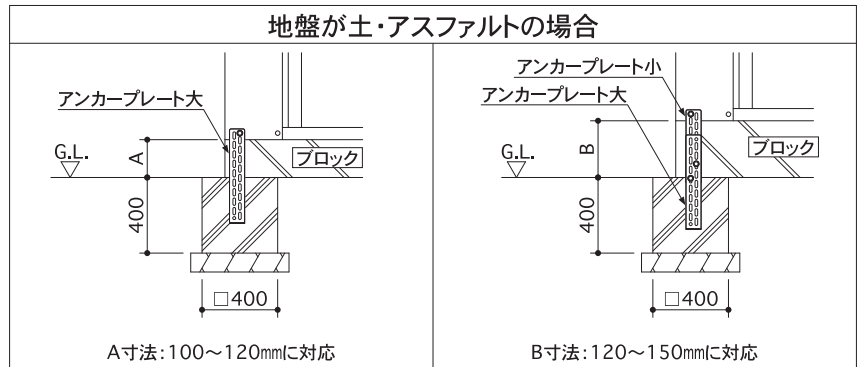
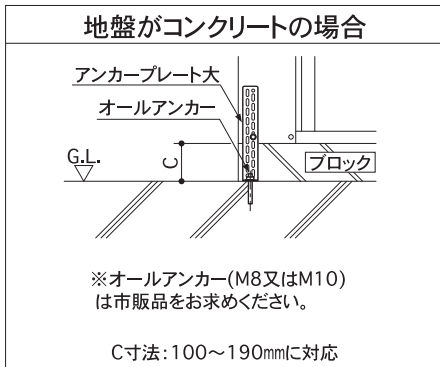

TP-4019(右物置)

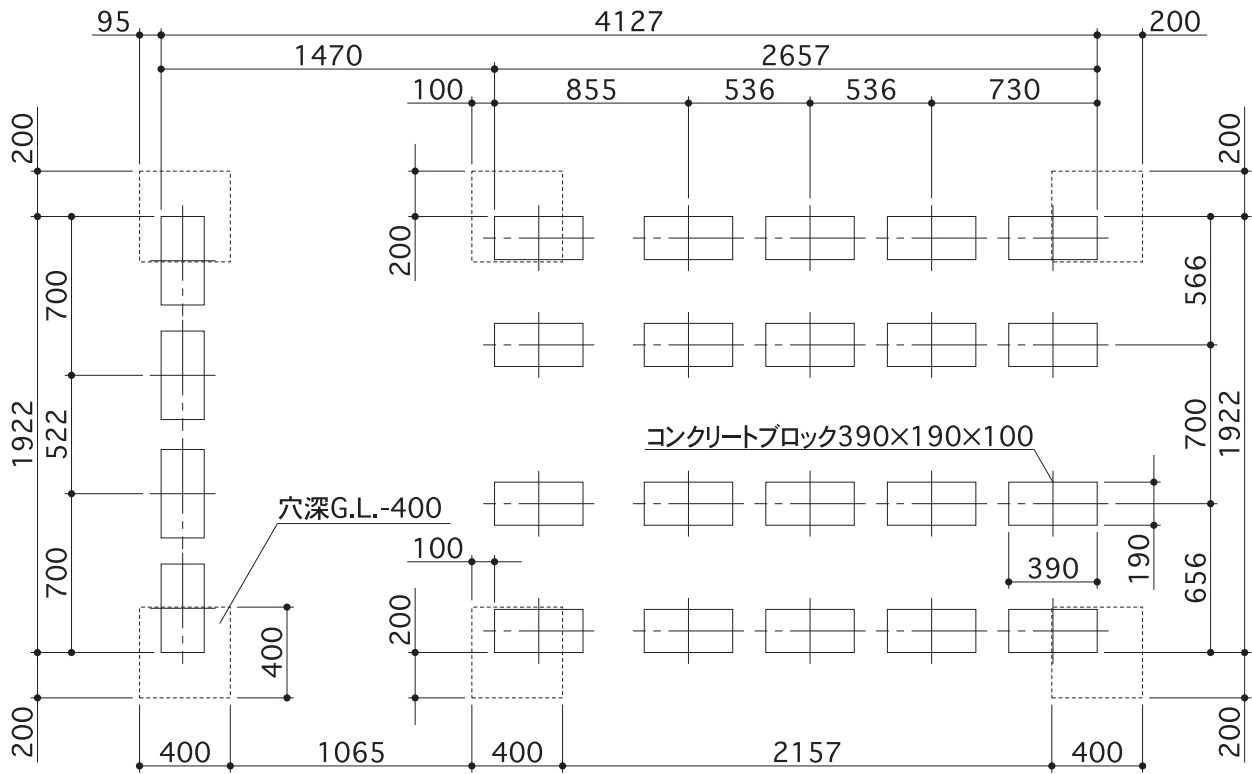

出入口側

