

TP-3726(左物置)

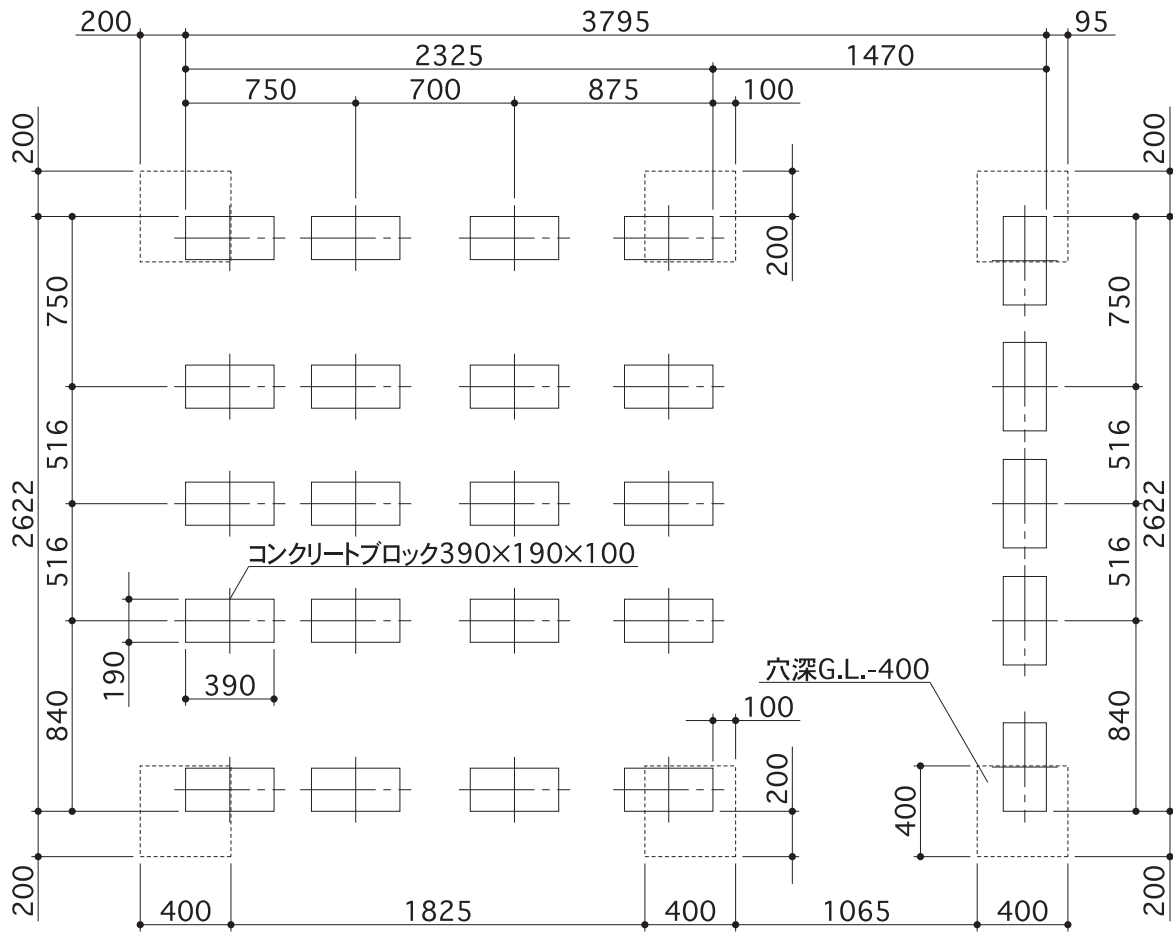

出入口側

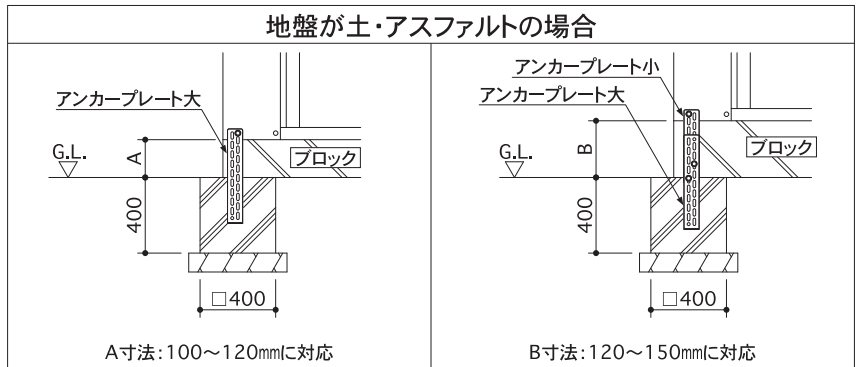
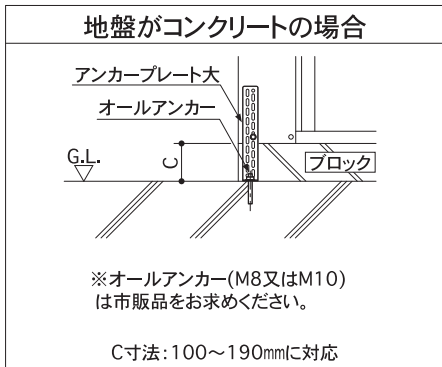

TP-3726(右物置)

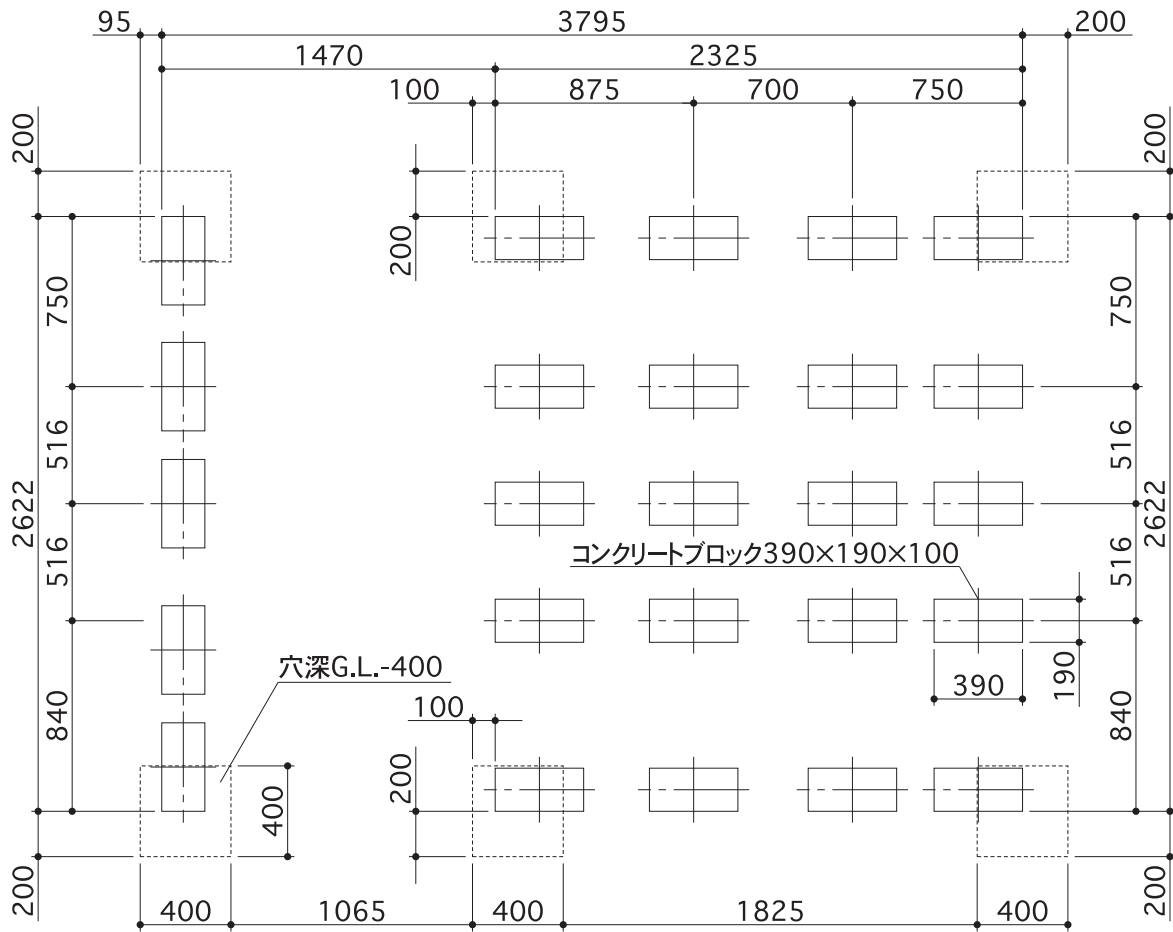

出入口側

