

# TP-3715(左物置)

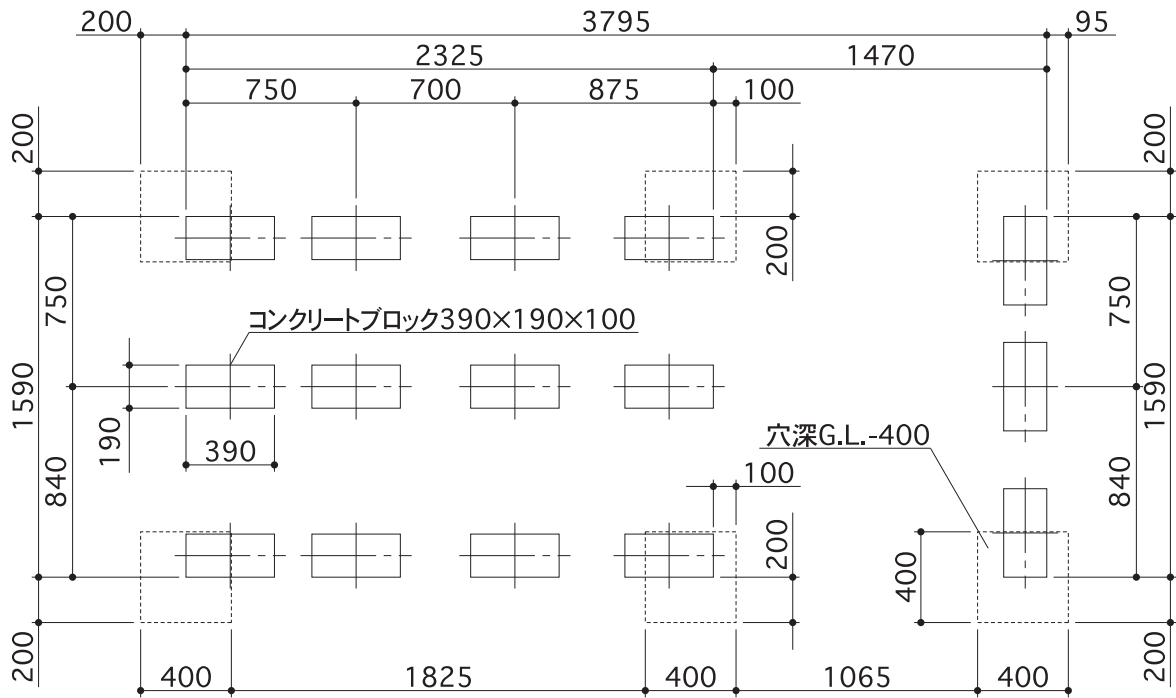

出入口側

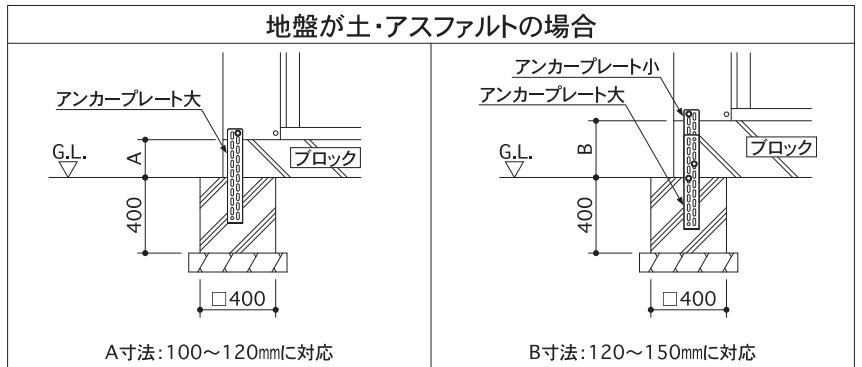
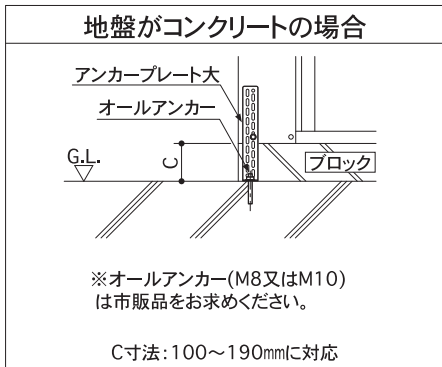

# TP-3715(右物置)

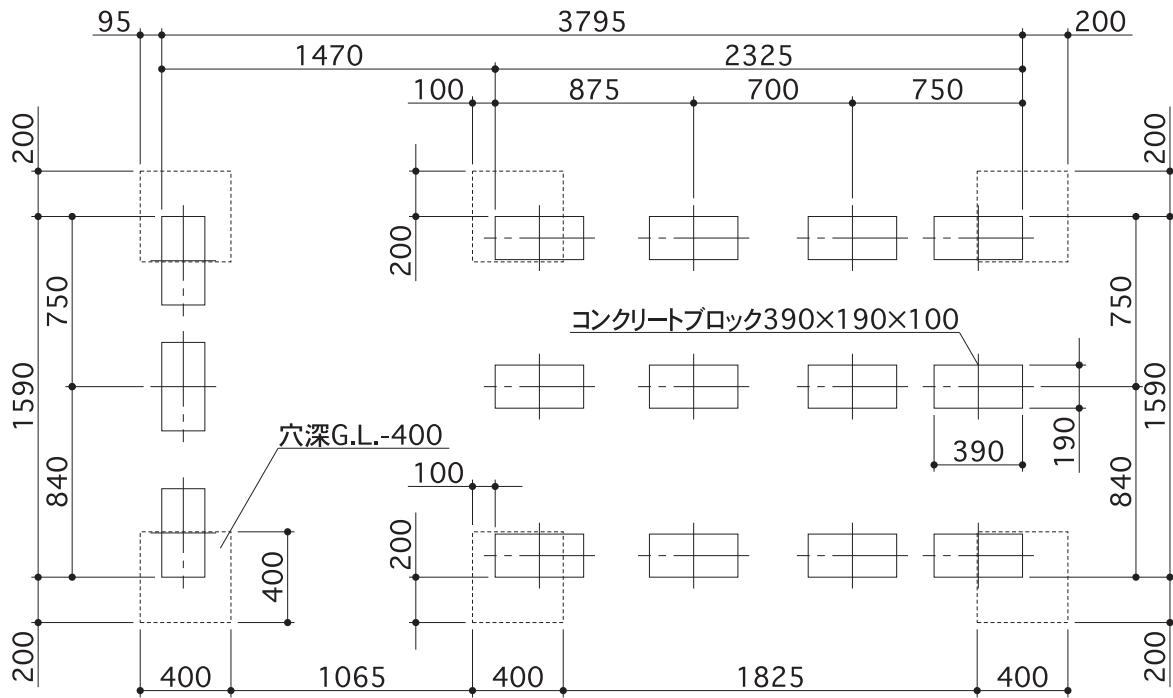

出入口側

