

# TP-3326(左物置)

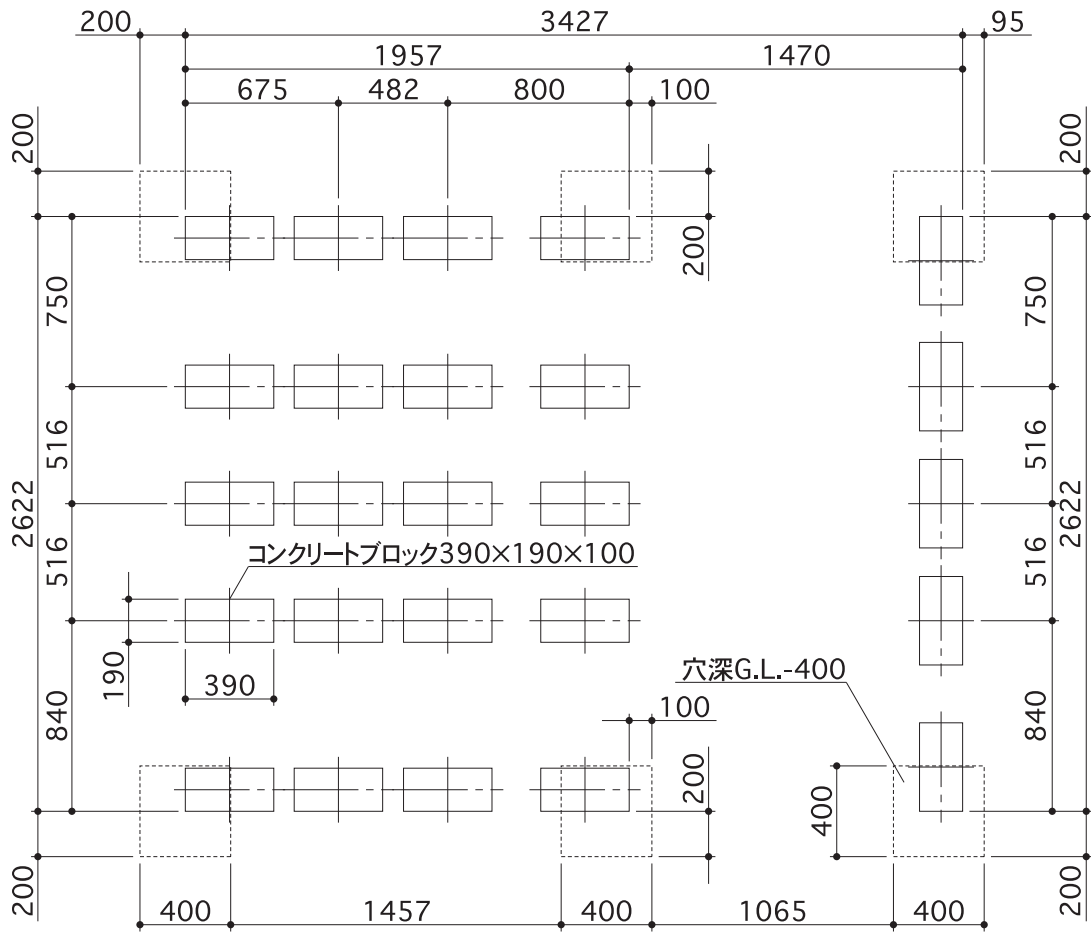

出入口側

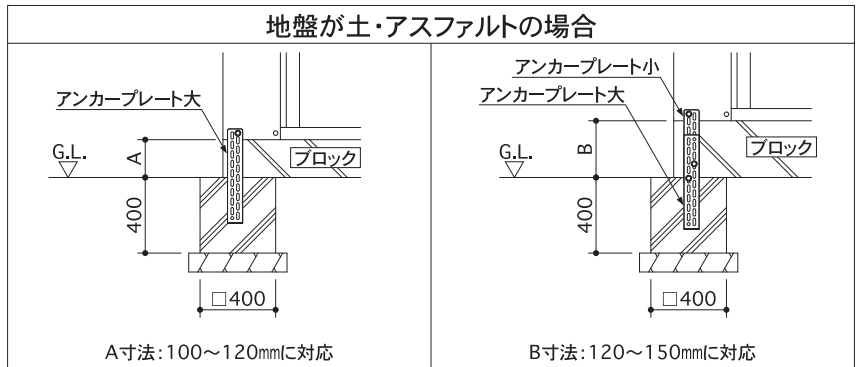
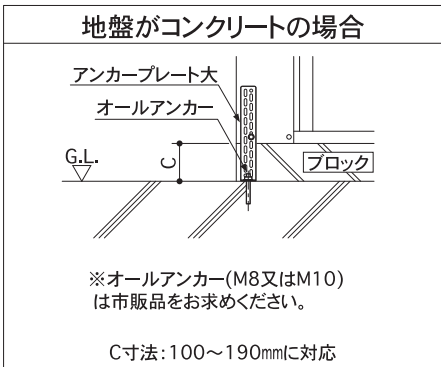

# TP-3326(右物置)

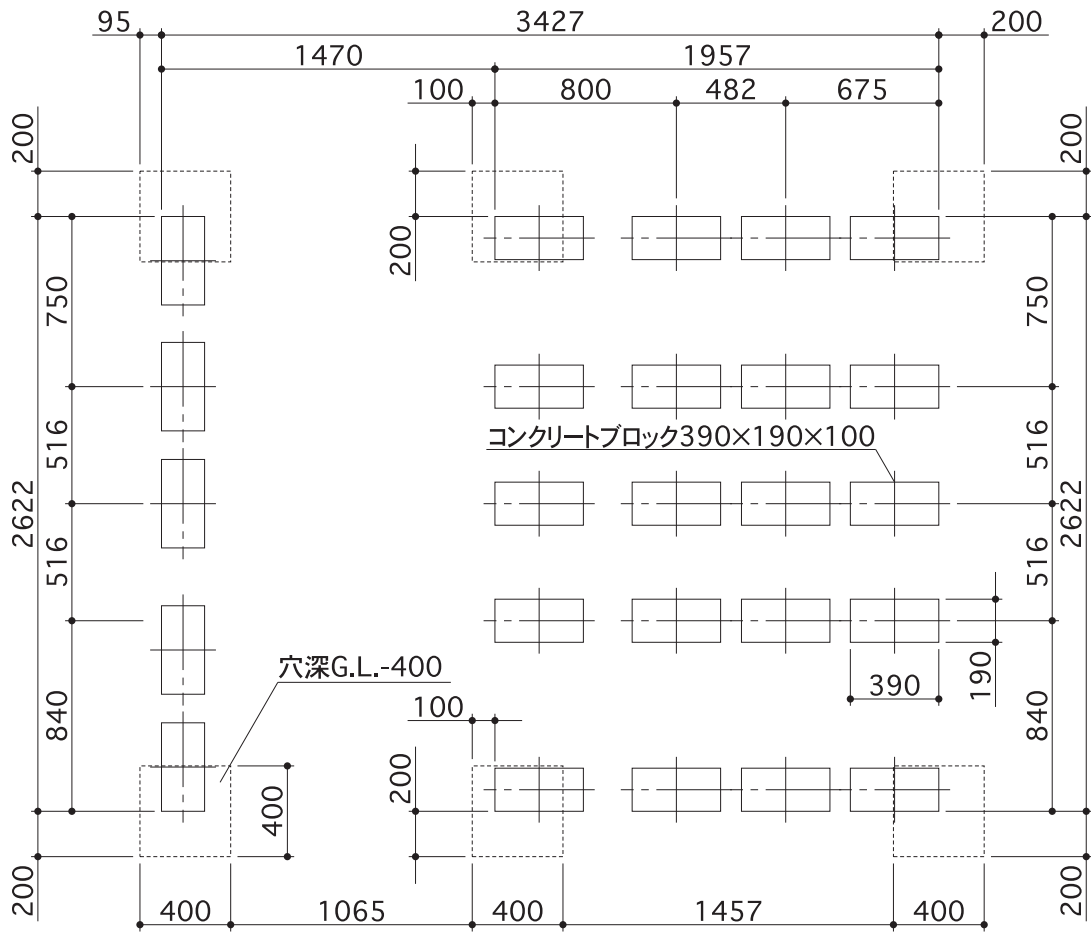

出入口側

