

# TP-3319(左物置)

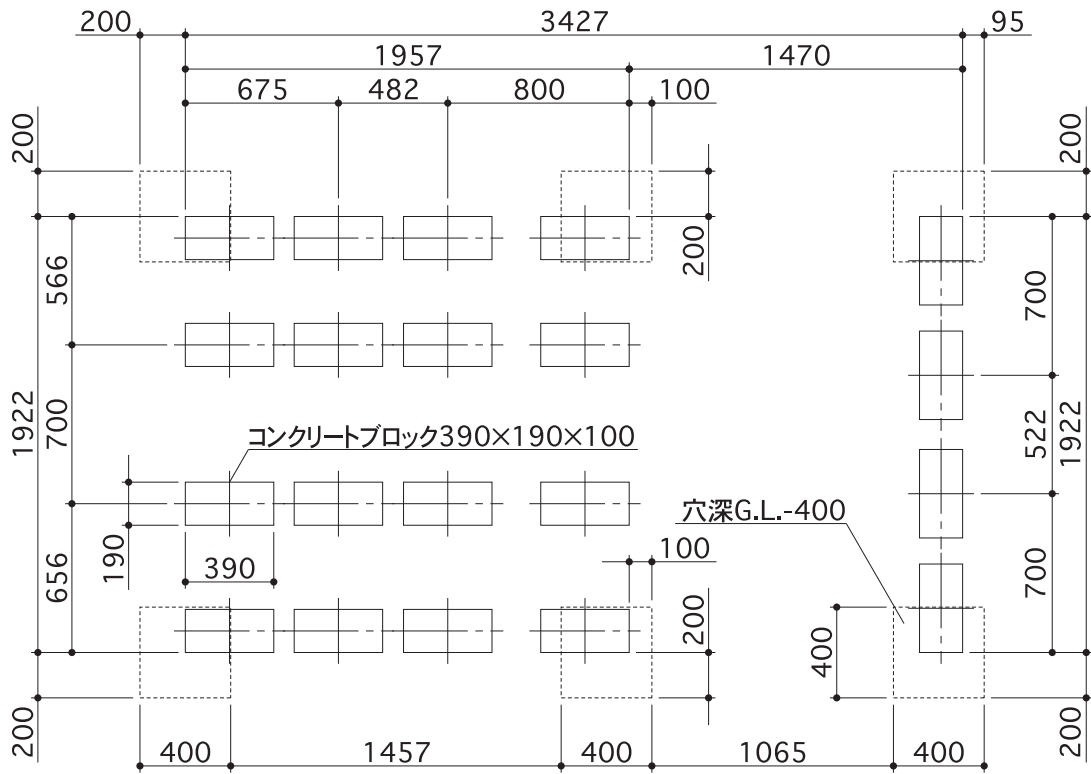

出入口側

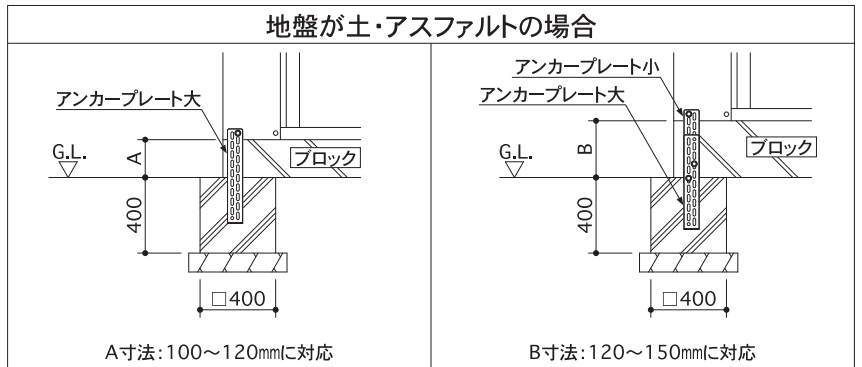
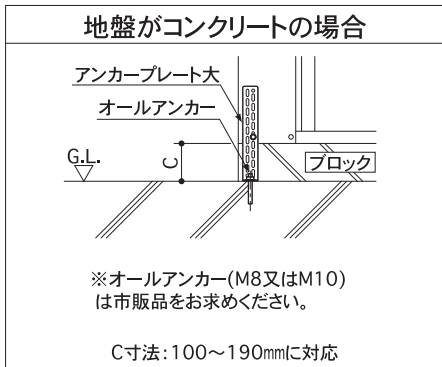

# TP-3319(右物置)

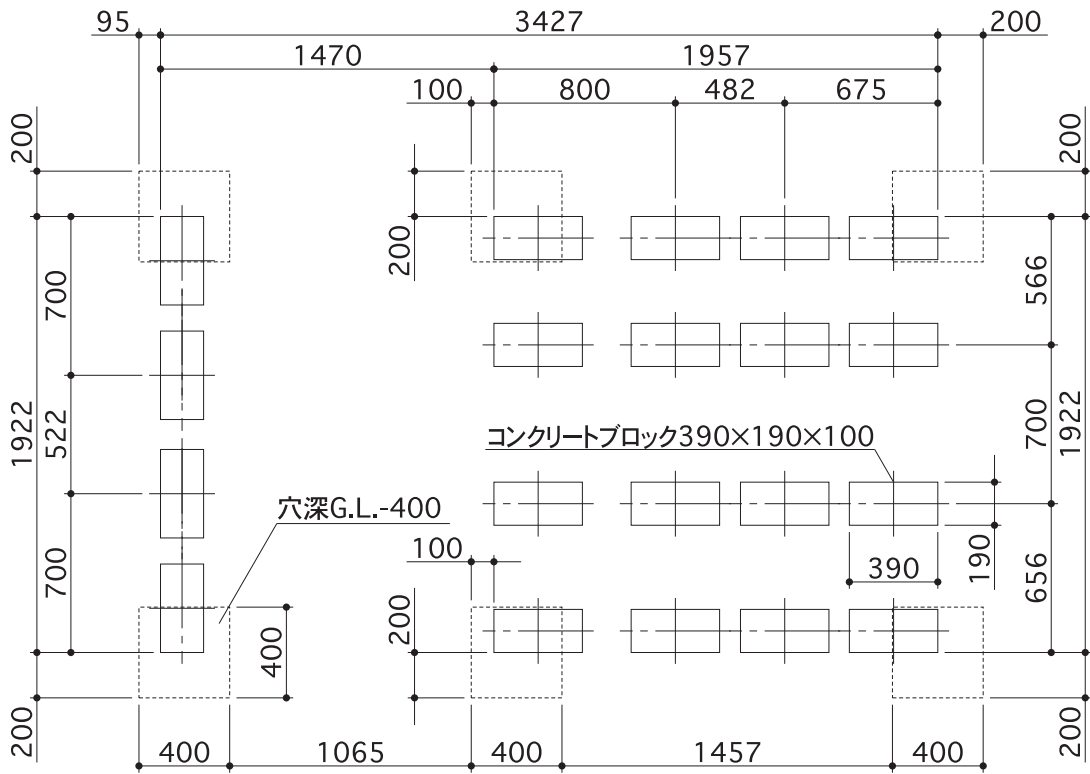

出入口側

