

TP-3026(左物置)

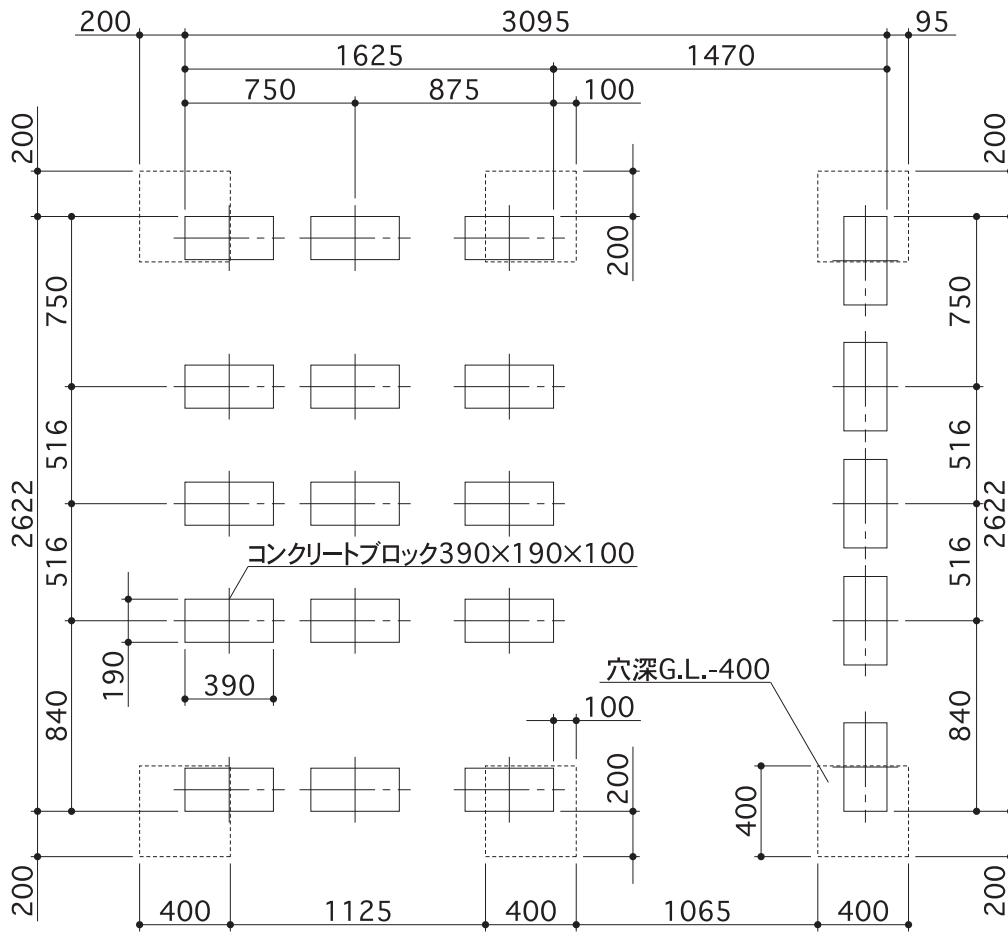

出入口側

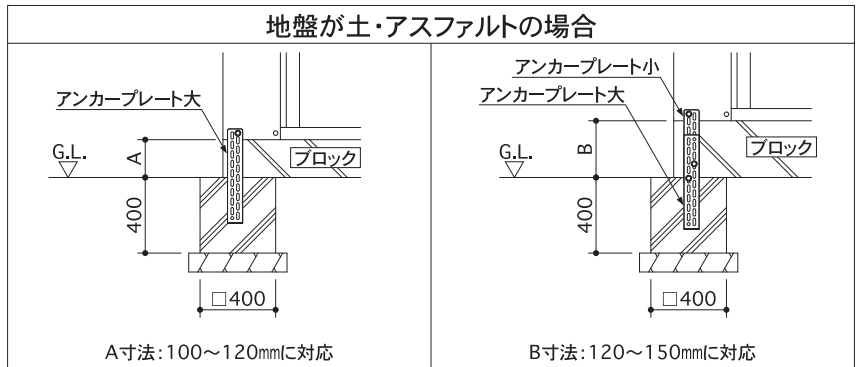
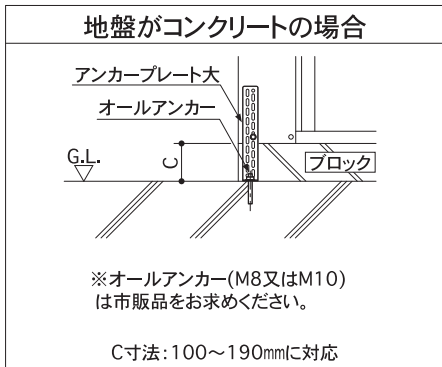

TP-3026(右物置)

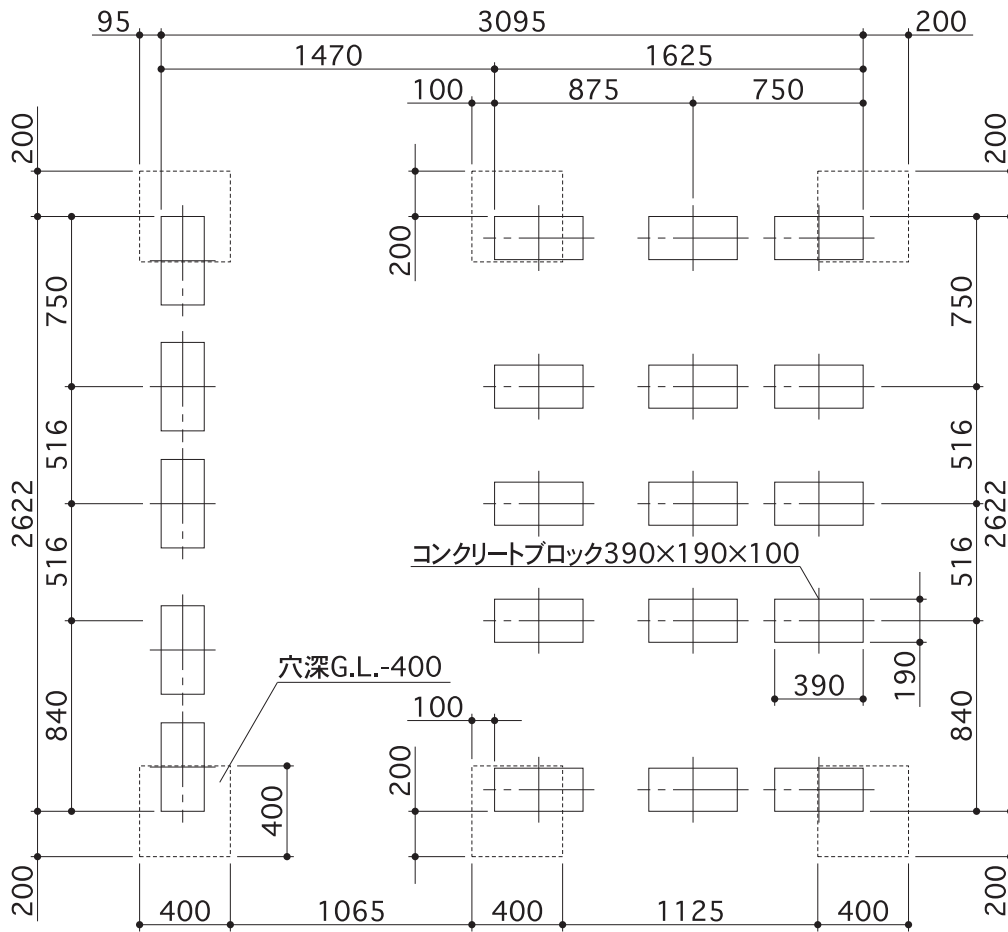

出入口側

