

TP-3019(左物置)

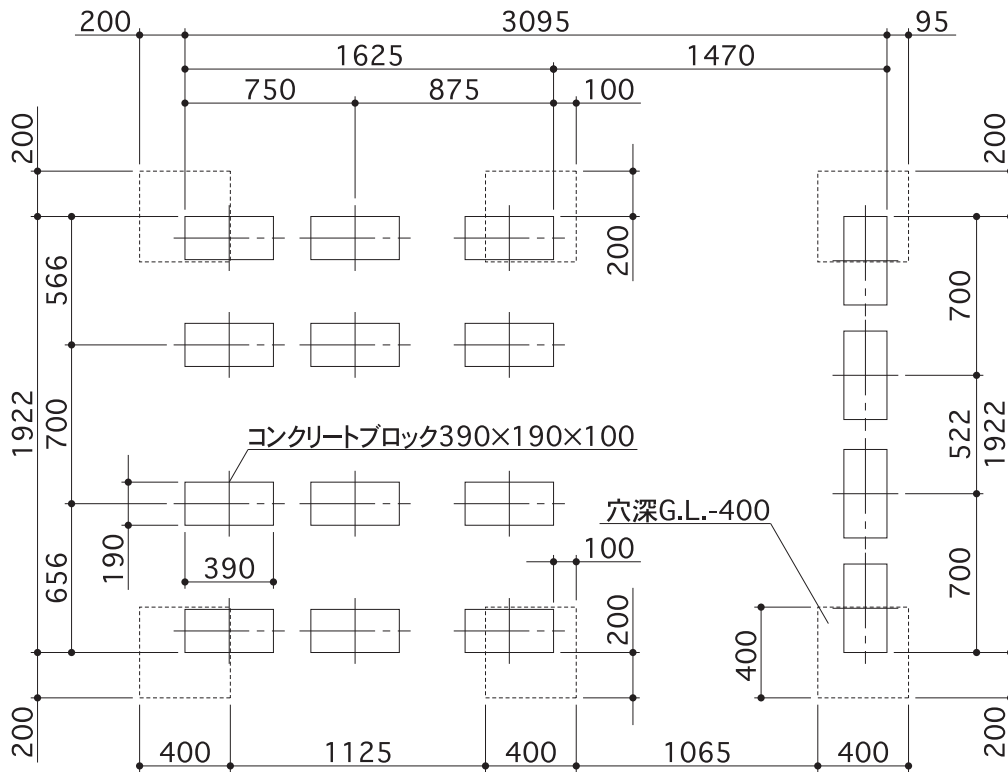

出入口側

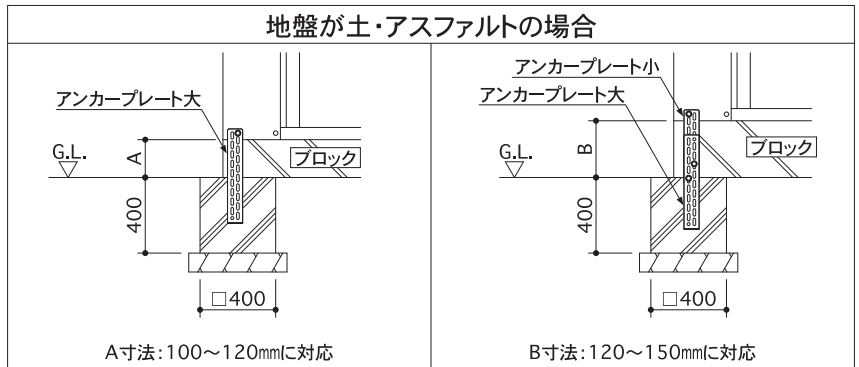
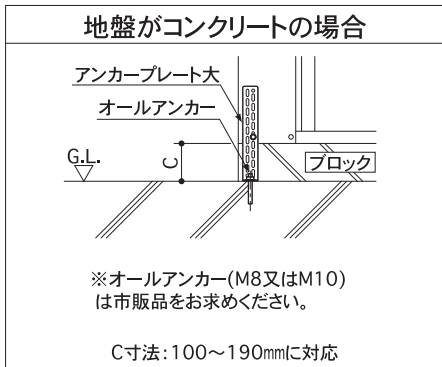

TP-3019(右物置)

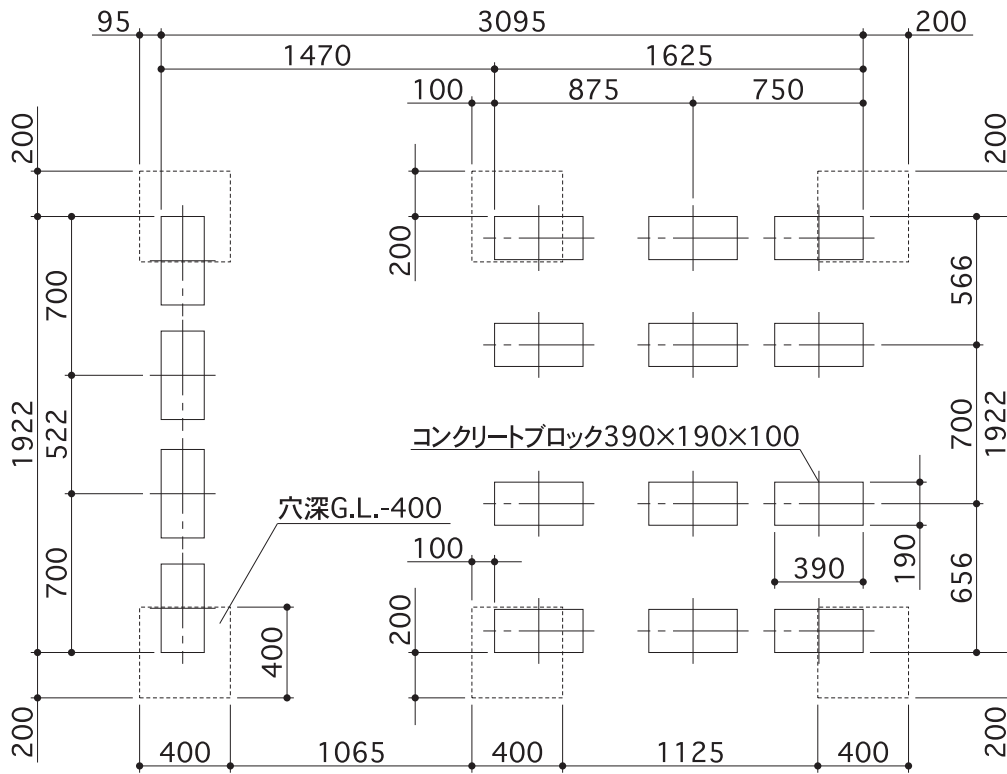

出入口側

