

TP-3015(左物置)

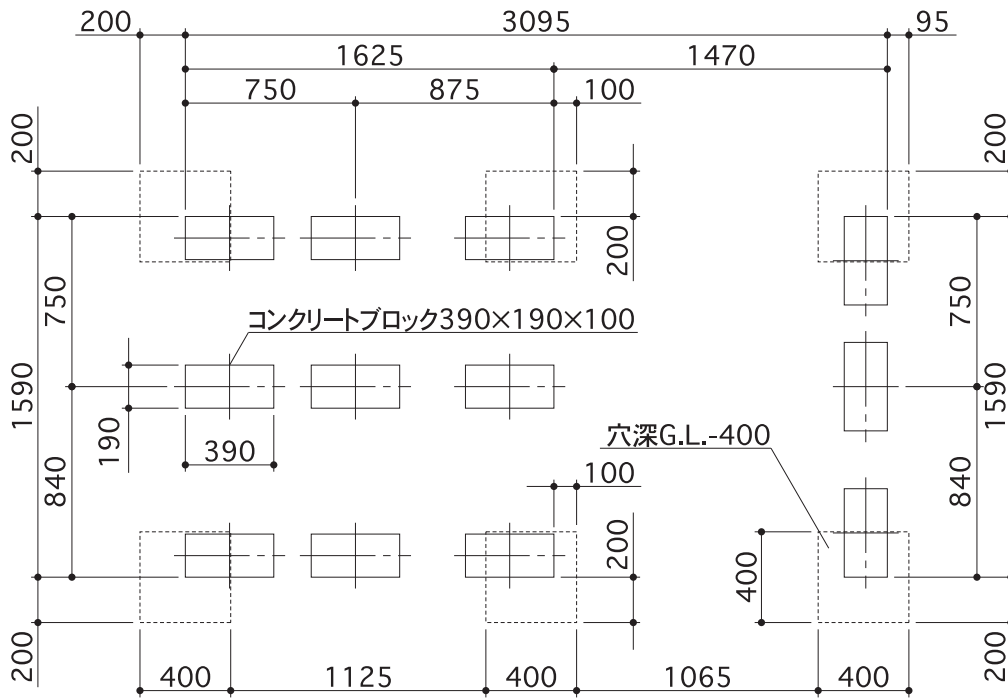

出入口側

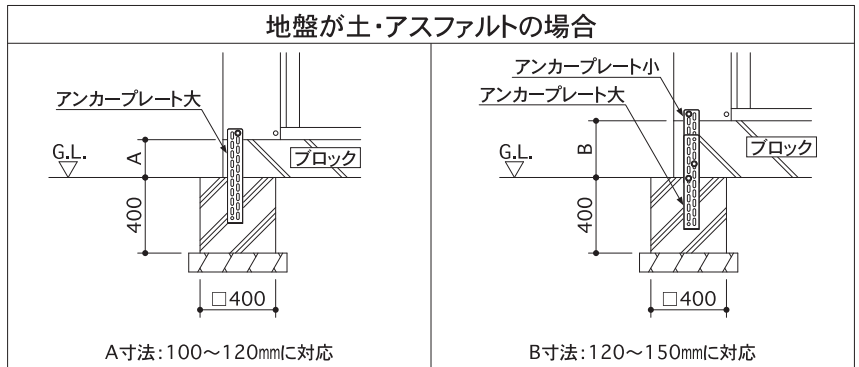
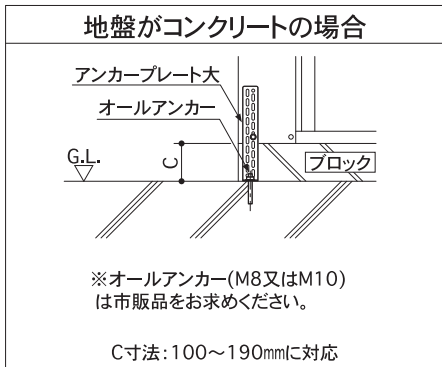

TP-3015(右物置)

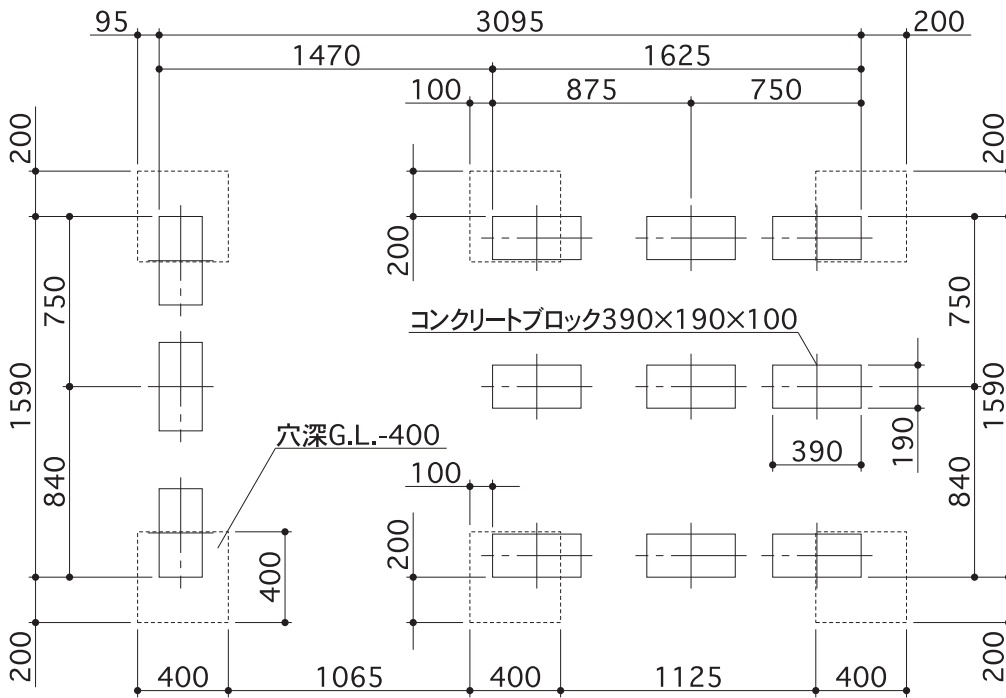

出入口側

