

# JNA-5019

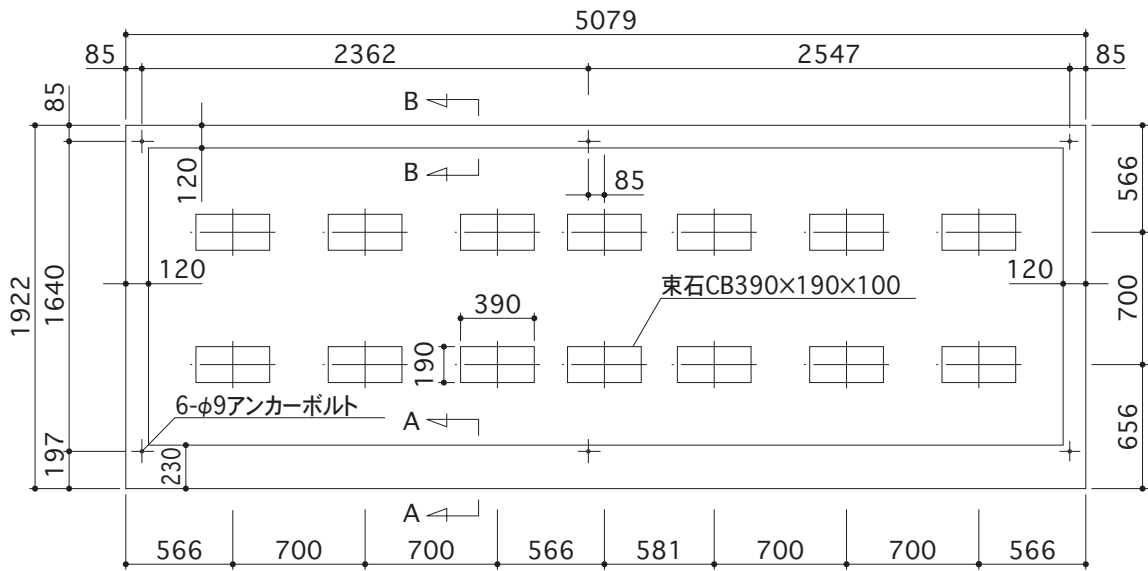

## 出入口側

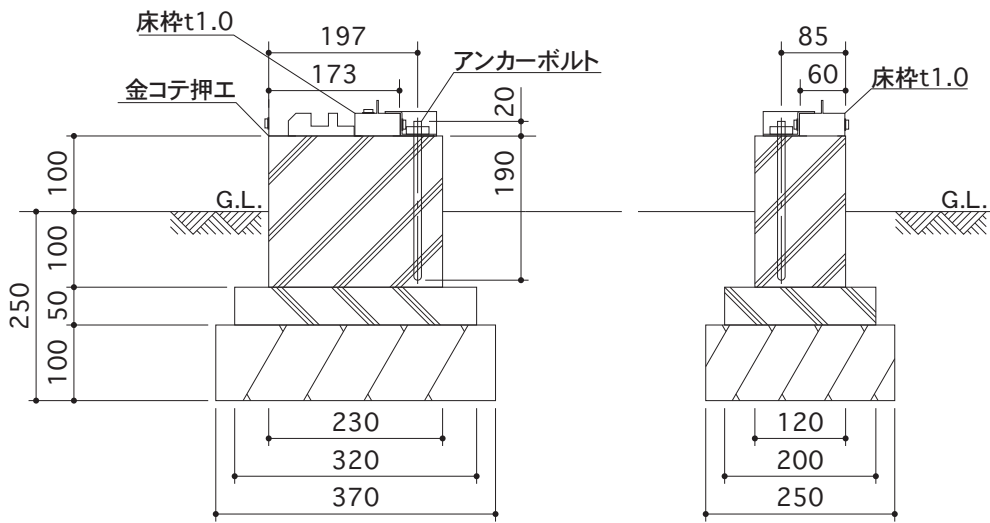

A-A断面図

B-B断面図