

# JNA-4419

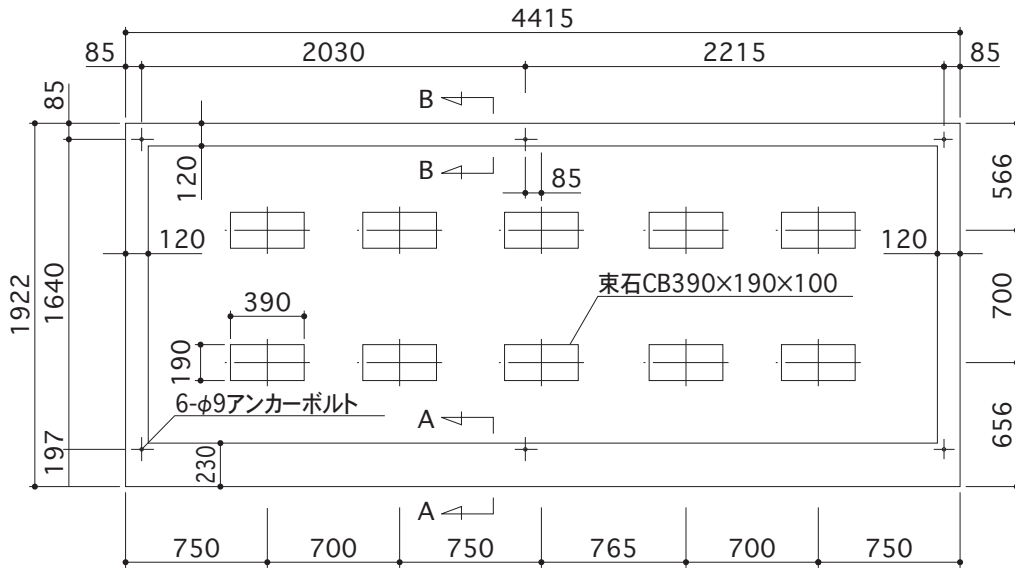

出入口側

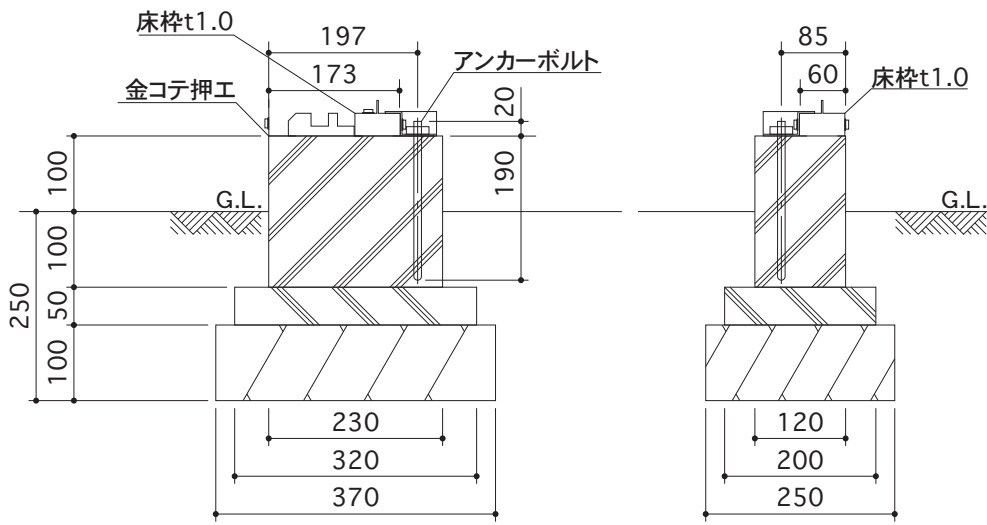

A-A断面図

B-B断面図