

# JN-4422

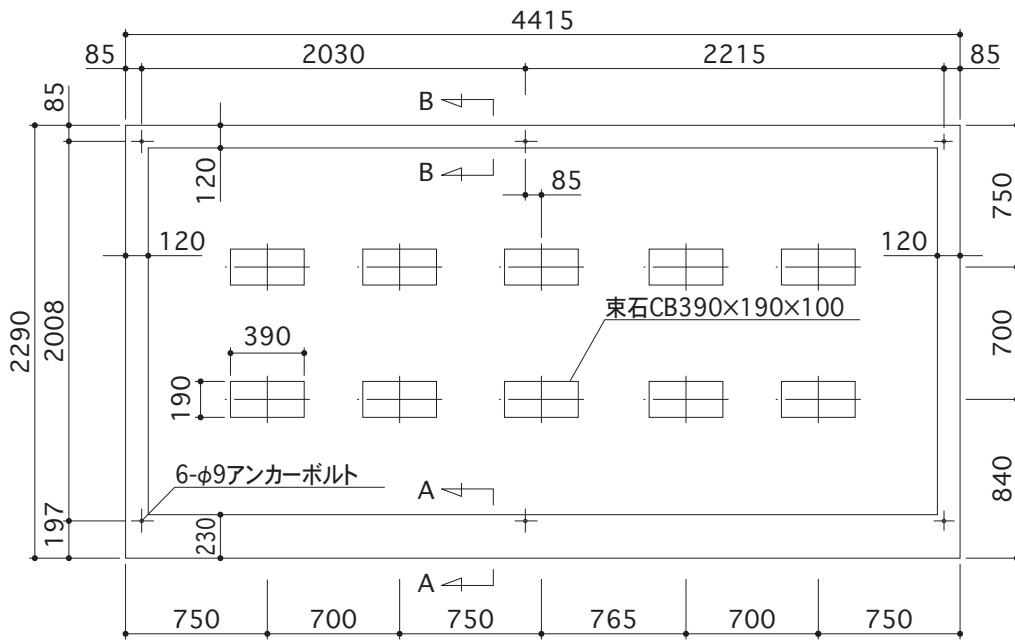

出入口側

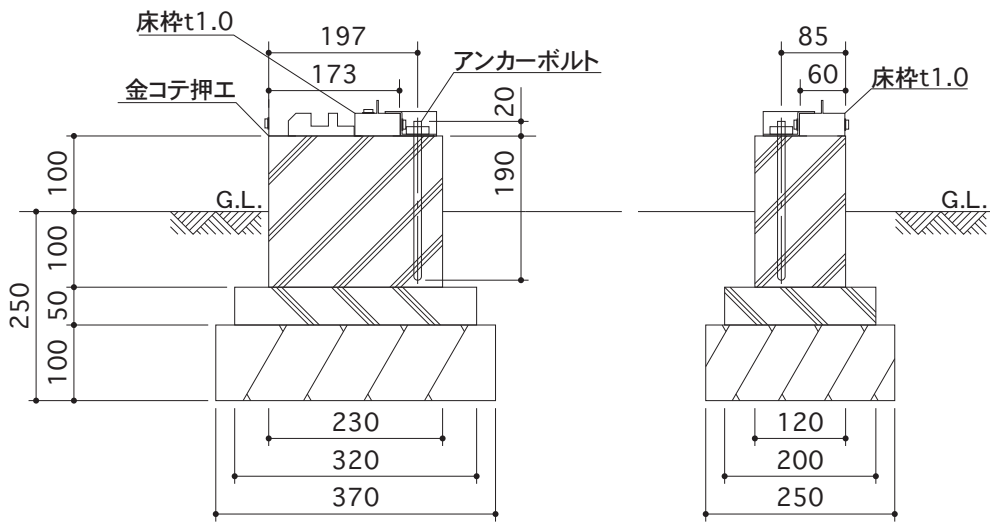

A-A断面図

B-B断面図